

CL Premiere 1.7/70 ASPHERIC

$f' = 70.0 \text{ mm}$ $\beta_p = 1.813$
 $s_F = -32.5 \text{ mm}$ $s_{EP} = 6.1 \text{ mm}$
 $s_{F'} = 41.8 \text{ mm}$ $s_{AP} = -85.2 \text{ mm}$
 $HH' = -8.7 \text{ mm}$ $\Sigma d = 57.0 \text{ mm}$

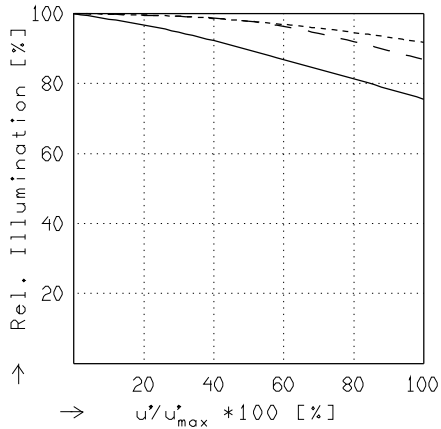
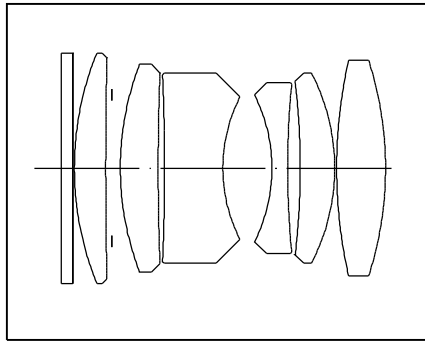

RELATIVE ILLUMINATION

The relative illumination is shown for the given focal distances or magnifications.

$f / 1.7$

— $\beta' = 0.0000$ $u'_{max} = 13.9$ $00' = \infty$
 - - $\beta' = 0.0000$ $u'_{max} = 13.9$ $00' = \infty$
 ···· $\beta' = 0.0000$ $u'_{max} = 13.9$ $00' = \infty$

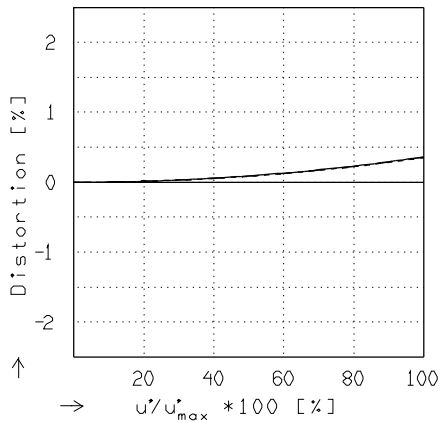

DISTORTION

Distortion is shown for the given focal distances or magnifications. Positive values indicate pincushion distortion and negative values barrel distortion.

— $\beta' = 0.0000$ $u'_{max} = 13.9$ $00' = \infty$
 - - $\beta' = 0.0000$ $u'_{max} = 13.9$ $00' = \infty$
 ···· $\beta' = 0.0000$ $u'_{max} = 13.9$ $00' = \infty$

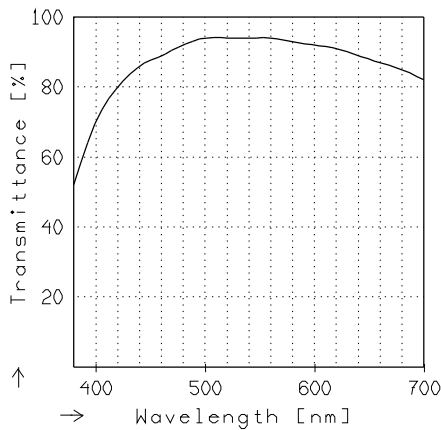

TRANSMITTANCE

Relative spectral transmittance is shown with reference to wavelength.

Jos. Schneider Optische Werke GmbH
 Ringstrasse 132 55543 Bad Kreuznach Germany

CL Premiere 1.7/70 ASPHERIC

MODULATION with reference to the relative image height

Wavelength λ	[nm]	546	644	610	570	510	480
Spectral weighting	[%]	28.3	4.5	17.8	29.4	16.0	4.0
Spatial frequency R	[1/mm]	20	40	80			
Format	[mm X mm]	18.0	X	21.3			
Diagonal $2u'$	[mm]	27.7					

radial ———
 tangential - - -

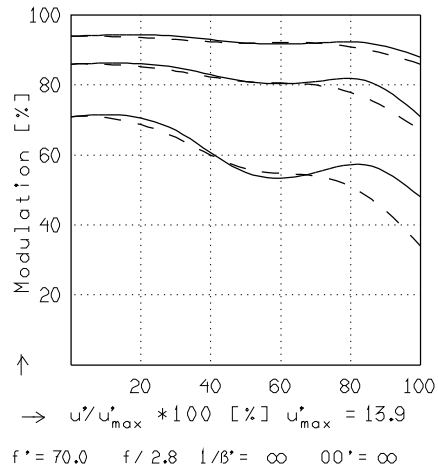
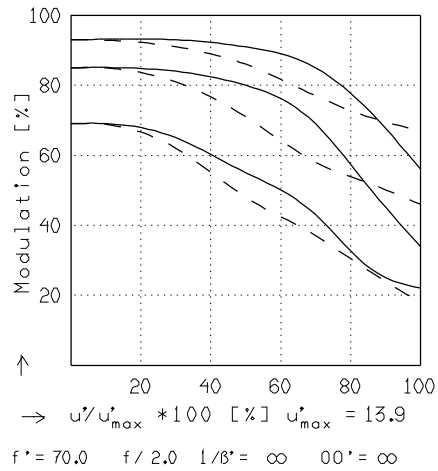
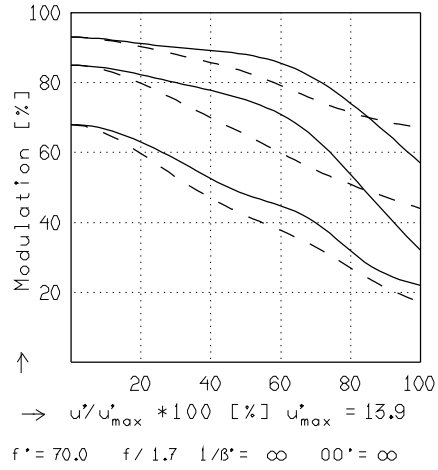

Focusing : MTF_{max} at $f / 1.7$, $R = 80$ 1/mm , $u'/u'_{max} = 0$

0.05
-0.135

0.05
-0.135

0.05
-0.135

47926 260104 Printed in the Federal Republic of Germany